

9998 OLD PLACERVILLE ROAD
 Sacramento, CA. 95827
 Phone: (916) 363-2681; Fax: (916) 363-4537
 www.claytonhomes.com www.karstenhomes.com

DRAWING TITLE:

SALES FLOOR PLAN

DRAWING FILE INFORMATION:

STANDARD AS OF REVISION DATE

PRODUCT:	CORONADO SERIES	DESRIIP.:	2446-A	MODEL NO.:	COR24463A
		SQUARE FT.:	1104 / 1199	DATE:	02/08/19
DRAWN BY:		SHEET:	1-A	REVISED:	05-03-2023

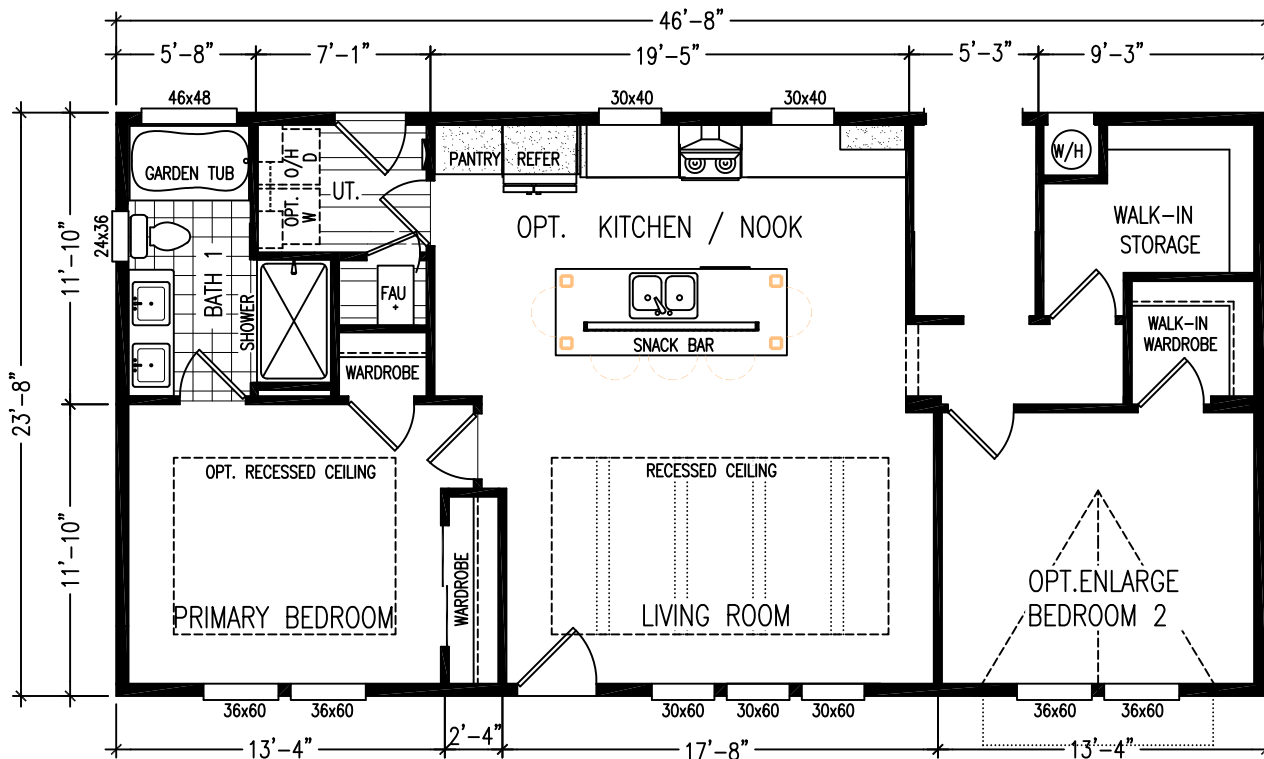

OPTIONAL PRIMARY
BATH / BEDROOM



9998 OLD PLACERVILLE ROAD
Sacramento, CA. 95827
Phone: (916) 363-2681; Fax: (916) 363-4537
www.claytonhomes.com www.karstenhomes.com

DRAWING
TITLE:

OPT. SALES FLOOR PLAN

DRAWING FILE INFORMATION:

STANDARD AS OF REVISION DATE

PRODUCT:

CORONADO SERIES

DESRIP.:

2446-A

MODEL NO.:

COR24463A

SQUARE FT.:

1104

DATE:

02/08/19

DRAWN BY:

SHEET:

1-B

REVISED:

11-03-20

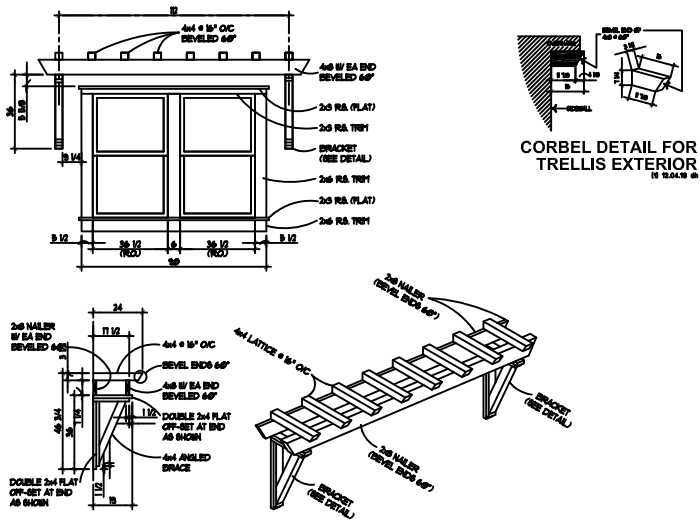

TRELLIS DETAILS

(2) REQUIRED - FIELD INSTALLED

CORBEL DETAIL FOR TRELLIS EXTERIOR

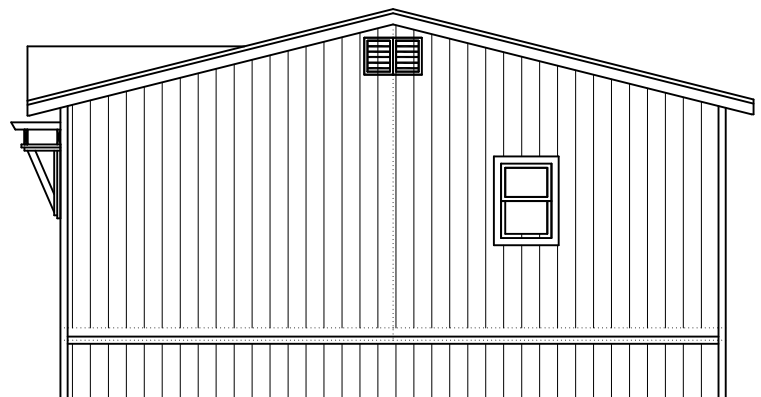

LEFT ENDWALL ELEVATION

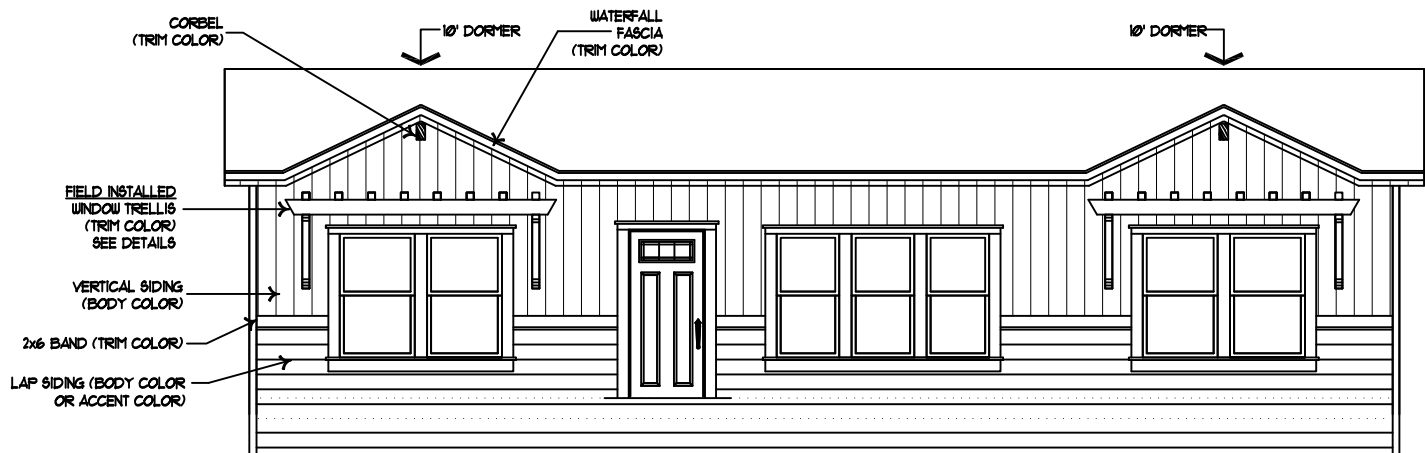

FRONT SIDEWALL ELEVATION

TRELLIS SIDEWALL EXTERIOR

NOTES:

1. 9' SIDEWALL WITH FLAT CEILING
2. ROOF PITCH 3:12



9998 OLD PLACERVILLE ROAD
 SACRAMENTO, CA. 95827
 Phone: (916) 363-2681; Fax: (916) 363-4537
 www.claytonhomes.com www.karstenhomes.com

DRAWING TITLE:

ELEVATIONS-3

DRAWING FILE INFORMATION:

STANDARD AS OF REVISION DATE

PRODUCT: CORONADO SERIES

DESRIIP.: 2446-A

MODEL NO.: COR24463A

SQUARE FT.:

DATE: 02/08/19

DRAWN BY:

SHEET:

REVISED: 08-20-20

2-C

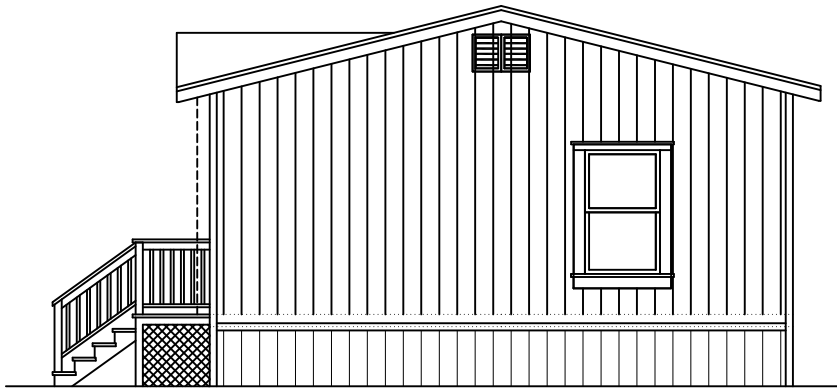

RIGHT ENDWALL ELEVATION

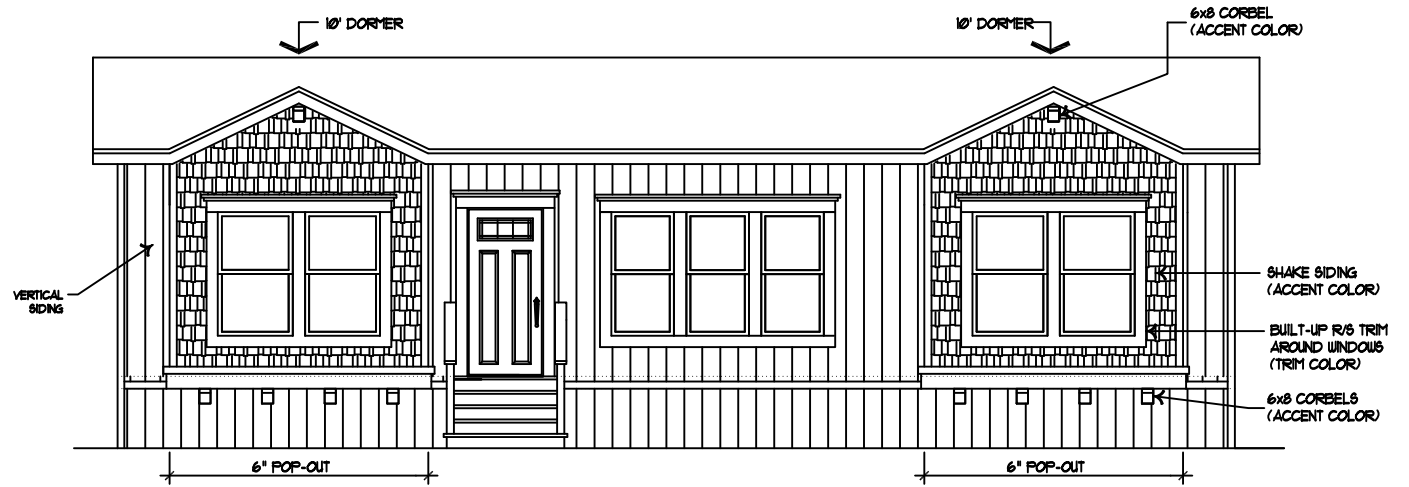

FRONT SIDEWALL ELEVATION

NOTES:

1. 9' SIDEWALL WITH FLAT CEILING
2. ROOF PITCH 3:12

"COSTAL SIDEWALL" EXTERIOR



9998 OLD PLACERVILLE ROAD
 SACRAMENTO, CA. 95827
 Phone: (916) 363-2681; Fax: (916) 363-4537
 www.claytonhomes.com www.karstenhomes.com

DRAWING
 TITLE:

ELEVATIONS - 4

DRAWING FILE INFORMATION:

STANDARD AS OF REVISION DATE

PRODUCT:

CORONADO SERIES

DESRIP.:

2446-A

MODEL NO.:

COR24463A

SQUARE FT.:

DATE:

02/08/19

DRAWN BY:

SHEET:

2-D

REVISED:

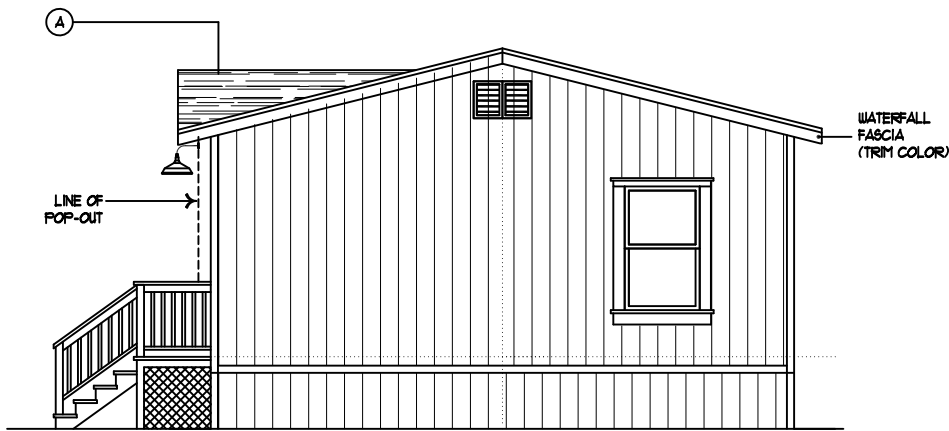

FRONT ENDWALL ELEVATION

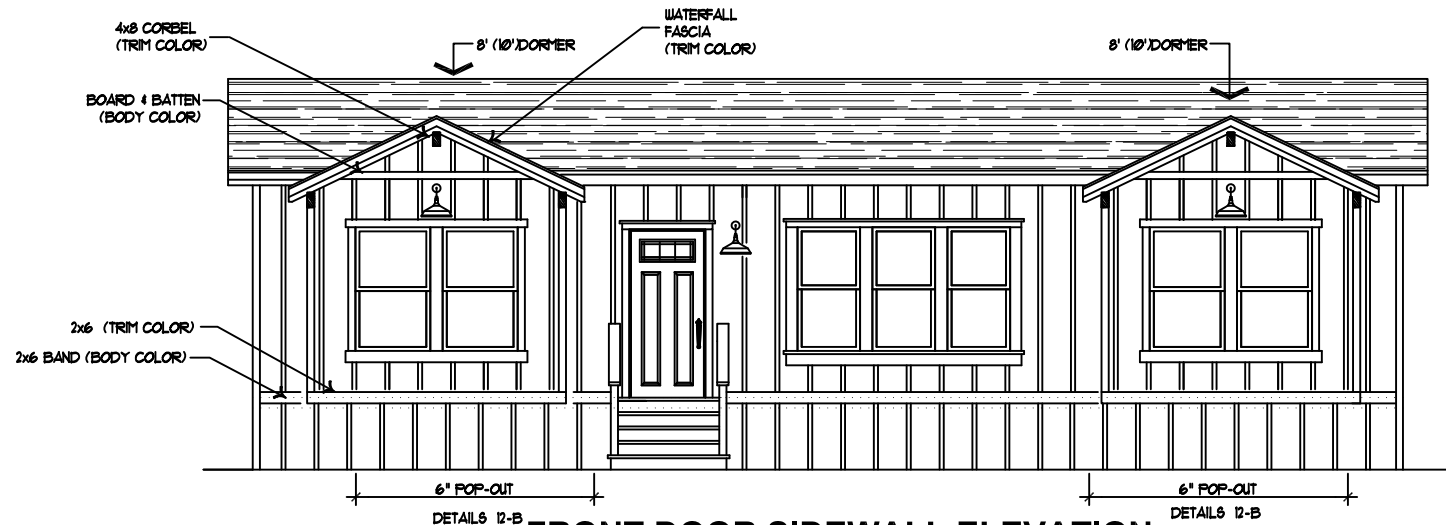

FRONT DOOR SIDEWALL ELEVATION

"FARMHOUSE SIDEWALL" EXTERIOR



9998 OLD PLACERVILLE ROAD
 SACRAMENTO, CA. 95827
 Phone: (916) 363-2681; Fax: (916) 363-4537
 www.claytonhomes.com www.karstenhomes.com

DRAWING
 TITLE:

EXTERIOR ELEVATIONS-5

DRAWING FILE INFORMATION:

STANDARD AS OF REVISION DATE

PRODUCT: CORONADO SERIES	DESRIP.: 2446-A	MODEL NO.: COR24463A
	SQUARE FT.:	DATE: 02/08/19
DRAWN BY:	SHEET: 2-E	REVISED: 08-20-20

1/20/19 11:01 AM C:\Users\jcarroll\OneDrive\Documents\Projects\Architect\STD\2019\COR_2446\COR24463A_1220.dwg