

9998 OLD PLACERVILLE ROAD
 SACRAMENTO, CA. 95827
 Phone: (916) 363-2681; Fax: (916) 363-4537
 www.claytonhomes.com www.karstenhomes.com

DRAWING TITLE:

SALES FLOOR PLAN

DRAWING FILE INFORMATION:

STANDARD AS OF REVISION DATE

PRODUCT: CORONADO SERIES	DESRIP.: 2446-3B	MODEL NO.: COR24463B
	SQUARE FT.: 1091/1186	DATE: 08/26/19
DRAWN BY:	SHEET:	REVISED: 02-05-2021

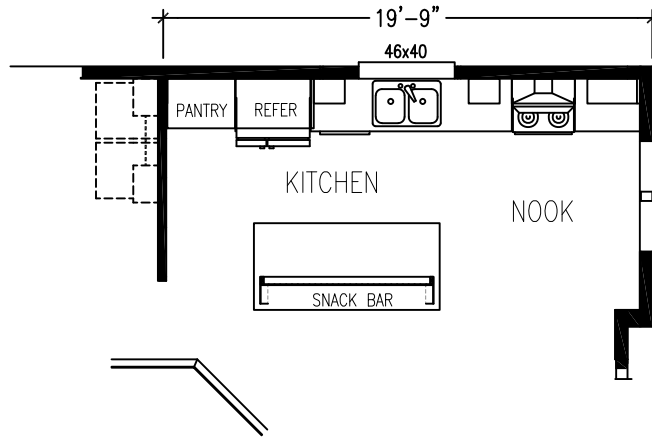
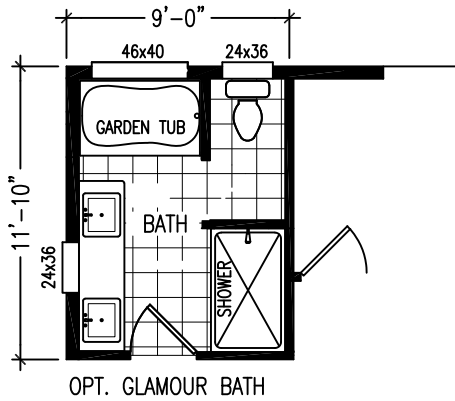

9998 OLD PLACERVILLE ROAD
 Sacramento, CA. 95827
 Phone: (916) 363-2681; Fax: (916) 363-4537
 www.claytonhomes.com www.karstenhomes.com

DRAWING
 TITLE:

OPT. SALES FLOOR PLAN

DRAWING FILE INFORMATION:

STANDARD AS OF REVISION DATE

PRODUCT: CORONADO SERIES	DESRIP.: 2446-3B	MODEL NO.: COR24463B
	SQUARE FT.: 1091/1186	DATE: 08/26/19
DRAWN BY:	SHEET:	REVISED: 02-05-2021

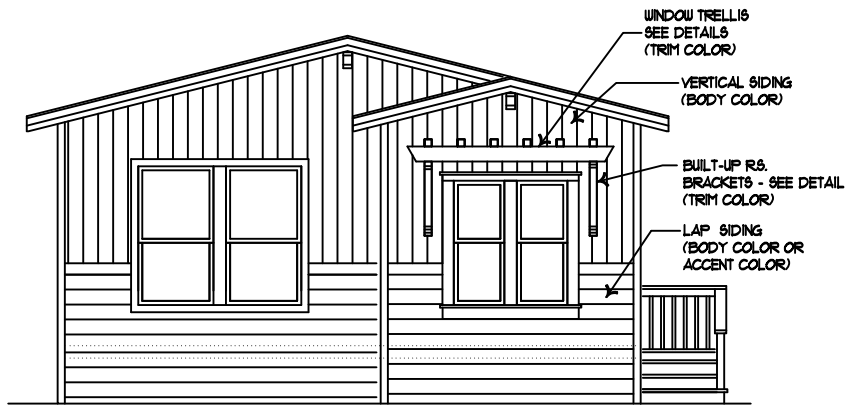

FRONT ENDWALL ELEVATION

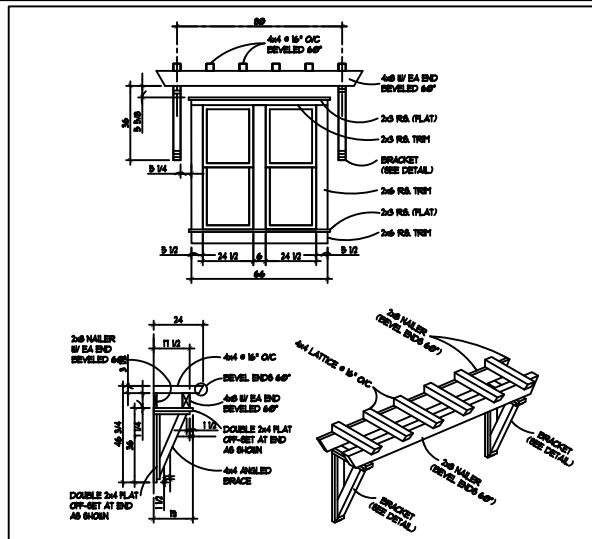

TRELLIS DETAILS

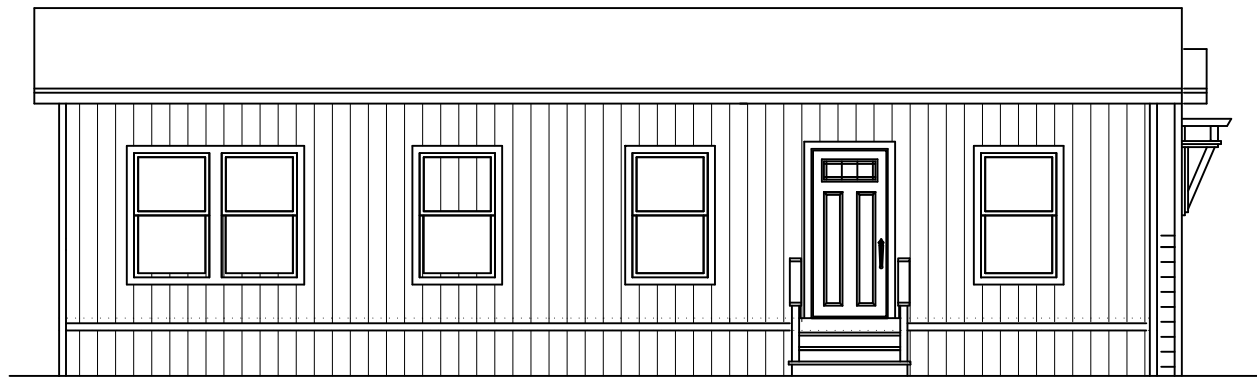

LEFT SIDEWALL ELEVATION

- NOTES:**
1. 9' SIDEWALL WITH FLAT CEILING
 2. ROOF PITCH 3:12

TRELLIS EXTERIOR

CMH 
MANUFACTURING INC.
 9998 OLD PLACERVILLE ROAD
 Sacramento, CA. 95827
 Phone: (916) 363-2681; Fax: (916) 363-4537
 www.claytonhomes.com www.karstenhomes.com

DRAWING TITLE: *EXTERIOR ELEVATIONS*

DRAWING FILE INFORMATION: STANDARD AS OF REVISION DATE

PRODUCT: CORONADO SERIES	DESIP.: 2446-3B	MODEL NO.: COR24463B
	SQUARE FT.:	DATE: 08/26/19
DRAWN BY:	SHEET: 2-A	REVISED: 08-20-13

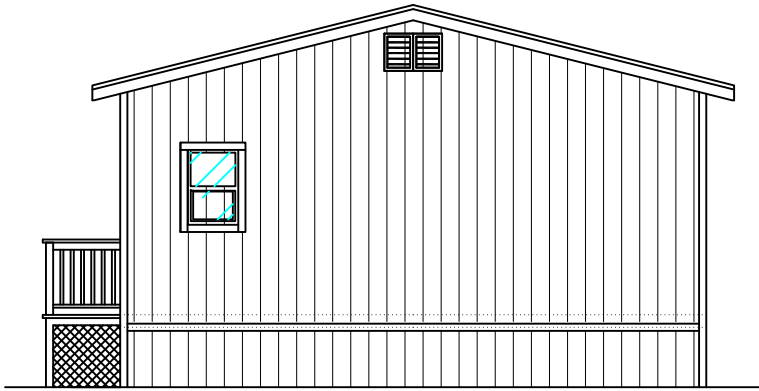

ENDWALL ELEVATION - REAR

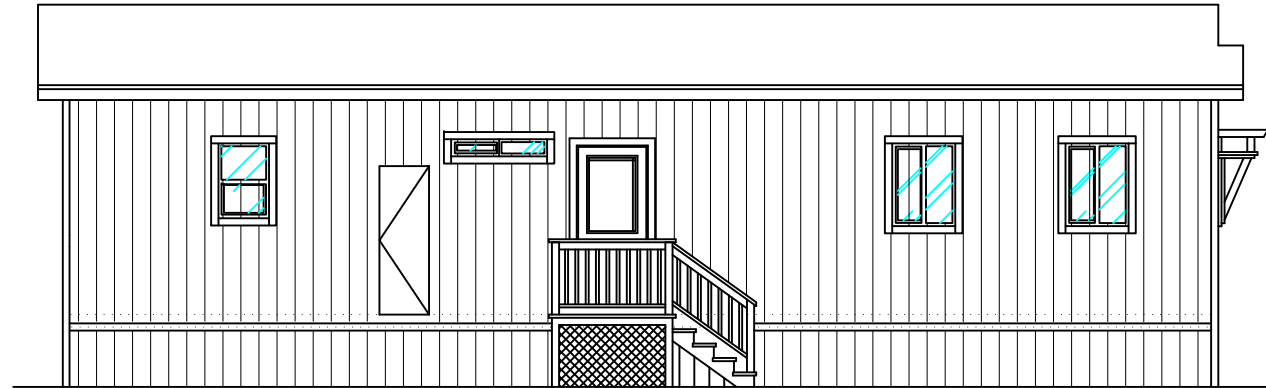

SIDEWALL ELEVATION - RIGHT



9998 OLD PLACERVILLE ROAD
 Sacramento, CA. 95827
 Phone: (916) 363-2681; Fax: (916) 363-4537
 www.claytonhomes.com www.karstenhomes.com

DRAWING
 TITLE:

EXTERIOR ELEVATIONS - 2

DRAWING FILE INFORMATION:

STANDARD AS OF REVISION DATE

PRODUCT: CORONADO SERIES	DESRI.P.: 2446-3B	MODEL NO.: COR24463B
	SQUARE FT.:	DATE: 08/26/19
DRAWN BY:	SHEET: 2-B	REVISED:



FRONT ENDWALL ELEVATION

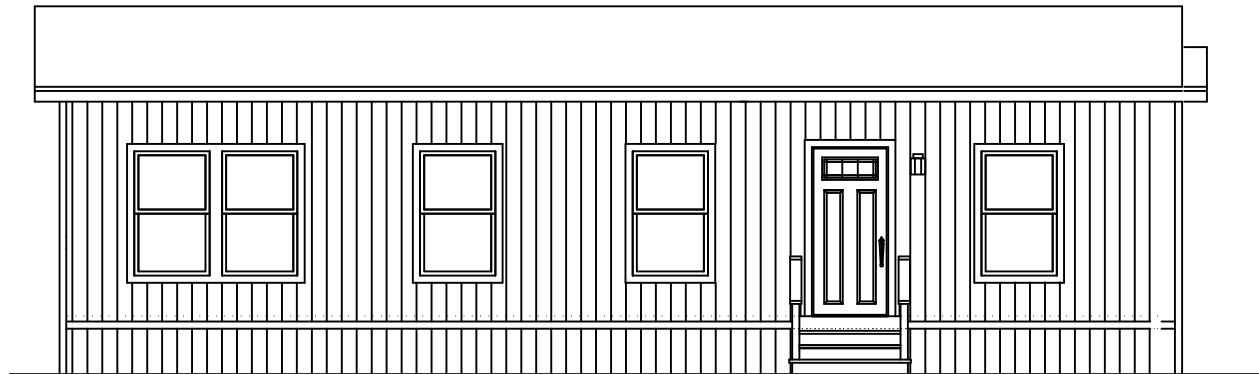

LEFT SIDEWALL ELEVATION

CRAFTSMAN OPTIONS



9998 OLD PLACERVILLE ROAD
 Sacramento, CA. 95827
 Phone: (916) 363-2681; Fax: (916) 363-4537
 www.claytonhomes.com www.karstenhomes.com

DRAWING
 TITLE:

EXTERIOR ELEVATIONS-3

DRAWING FILE INFORMATION:

STANDARD AS OF REVISION DATE

PRODUCT:

CORONADO SERIES

DESRI.P.:

2446-3B

MODEL NO.:

COR24463B

SQUARE FT.:

DATE:

08/26/19

DRAWN BY:

SHEET:

2-C

REVISED:

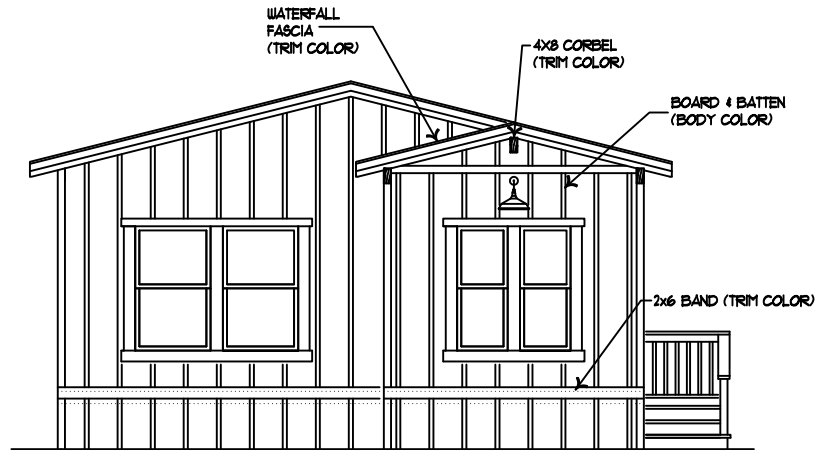

Front Elevation FARMHOUSE

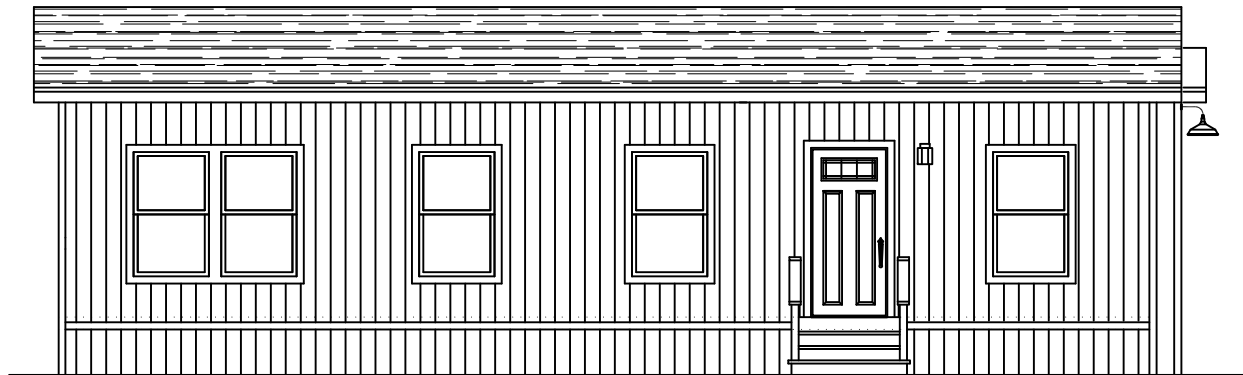

Left Side Elevation (FARMHOUSE)

FARMHOUSE EXTERIOR



9998 OLD PLACERVILLE ROAD
 Sacramento, CA. 95827
 Phone: (916) 363-2681; Fax: (916) 363-4537
 www.claytonhomes.com www.karstenhomes.com

DRAWING
 TITLE:

EXTERIOR ELEVATIONS-5

DRAWING FILE INFORMATION:

STANDARD AS OF REVISION DATE

PRODUCT: CORONADO SERIES	DESRI.P.: 2446-3B	MODEL NO.: COR24463B
	SQUARE FT.:	DATE: 08/26/19
DRAWN BY:	SHEET: 2-E	REVISED: